

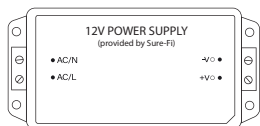

WIEGAND BRIDGE KIT QUICK START GUIDE

ITEMS INCLUDED:



2x

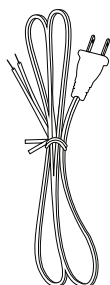

2x

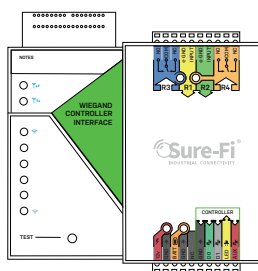

1x

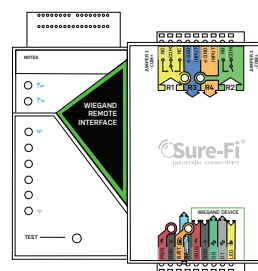

1x



1x

SIDE 1 - REMOTE INTERFACE

1 Connect to Wiegand device

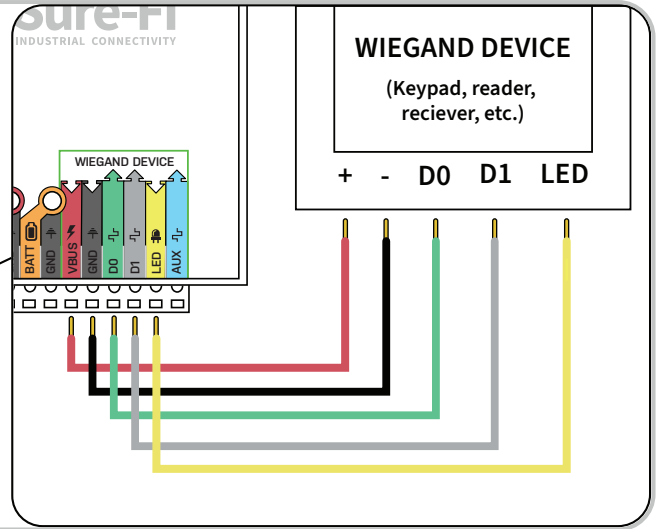
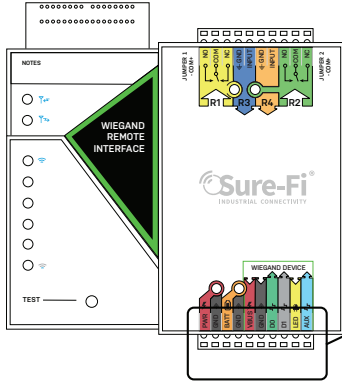

2A Connect to relay outputs to the door or gate hardware

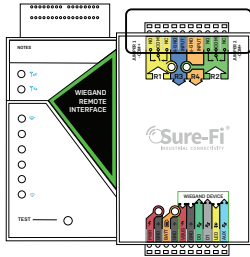

OR

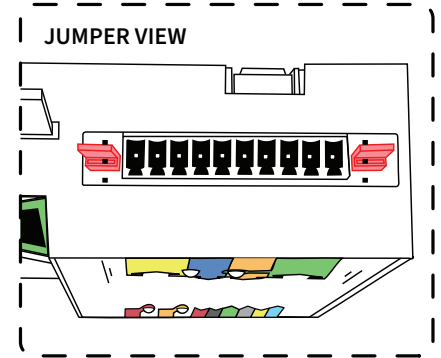
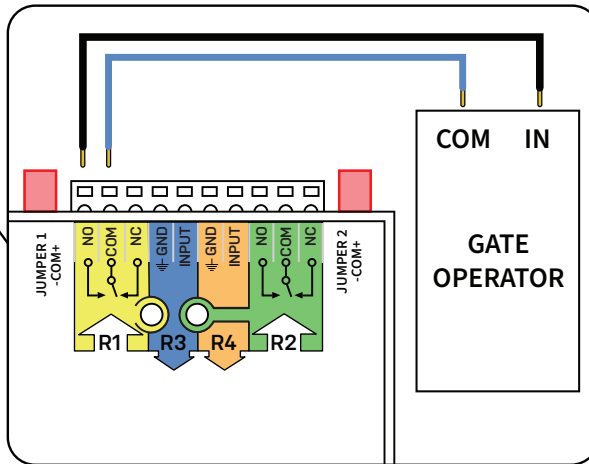

2B

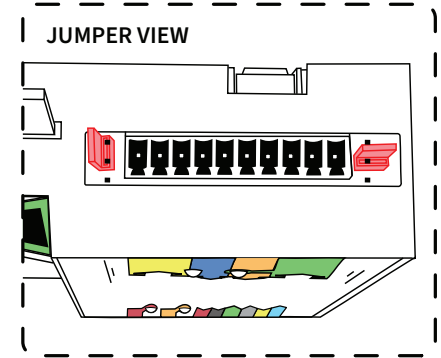
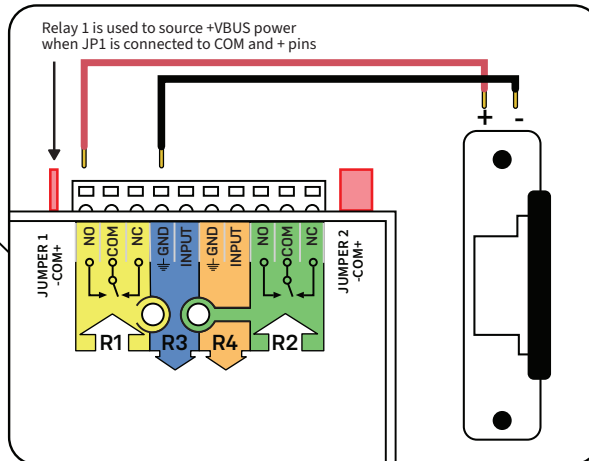
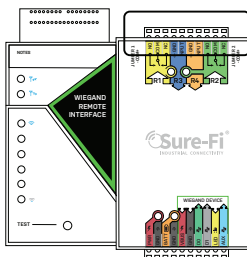

3 Connect to power

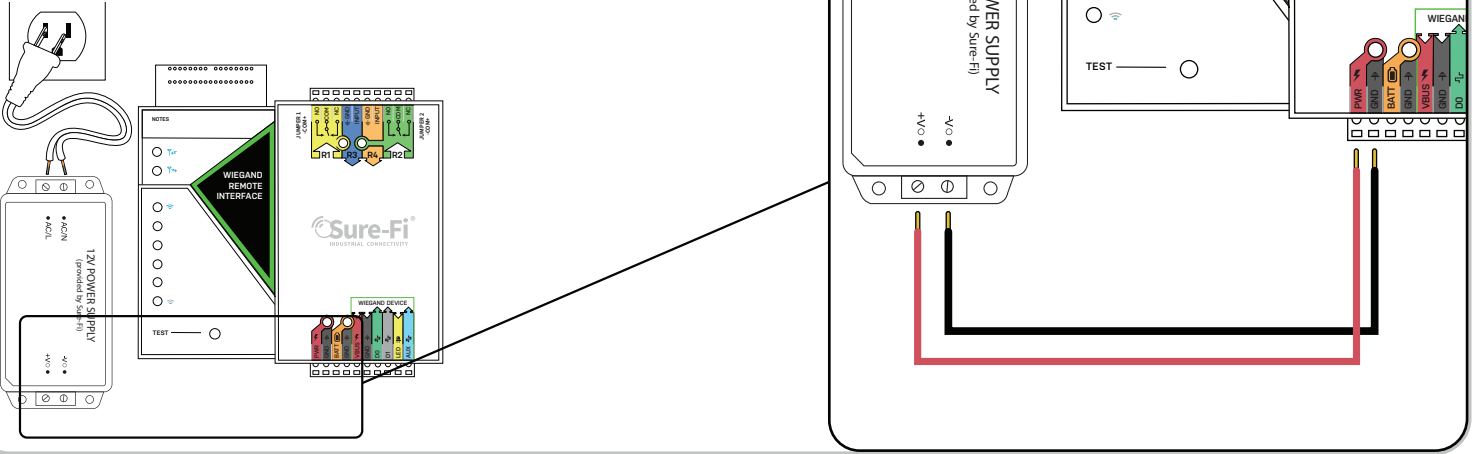

SIDE 2 - CONTROL PANEL

4 Connect controller interface wiegand data to control panel

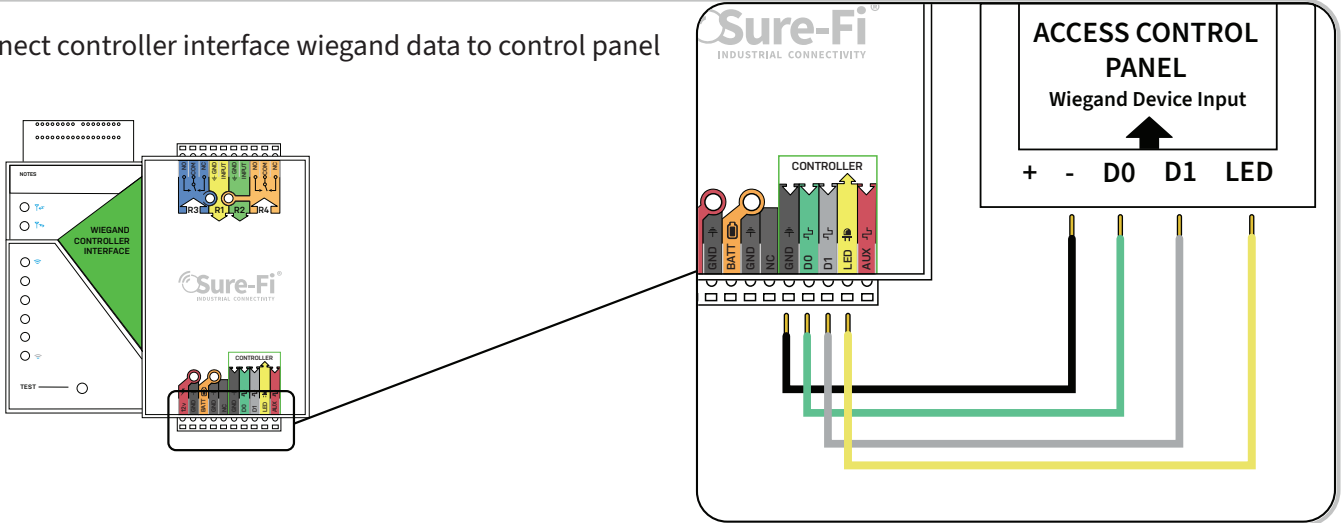

5 Connect relay input wires from control panel

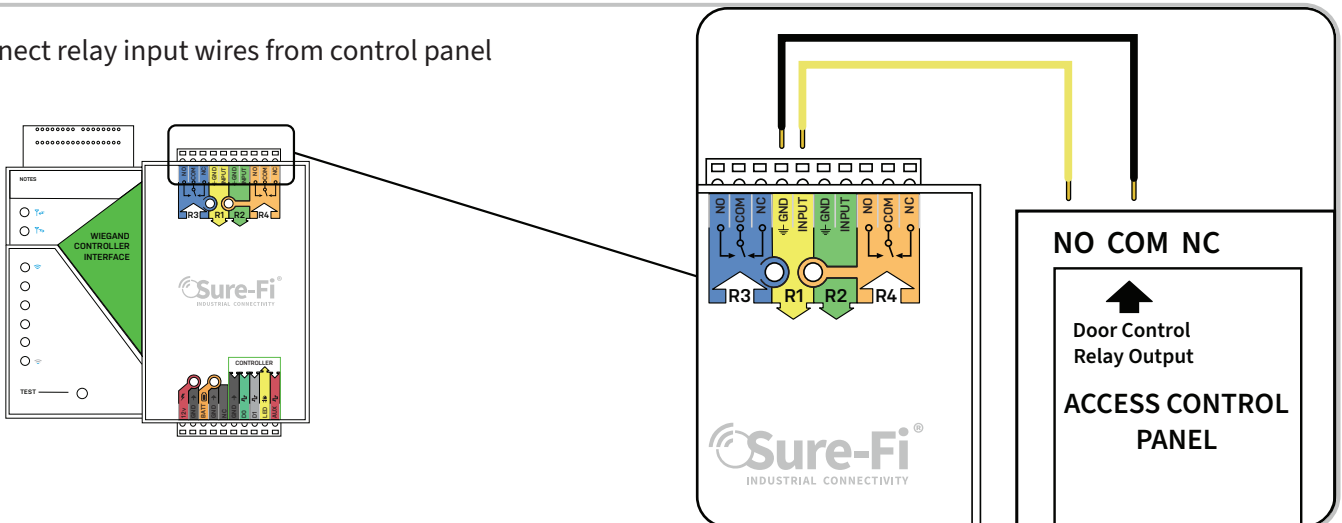

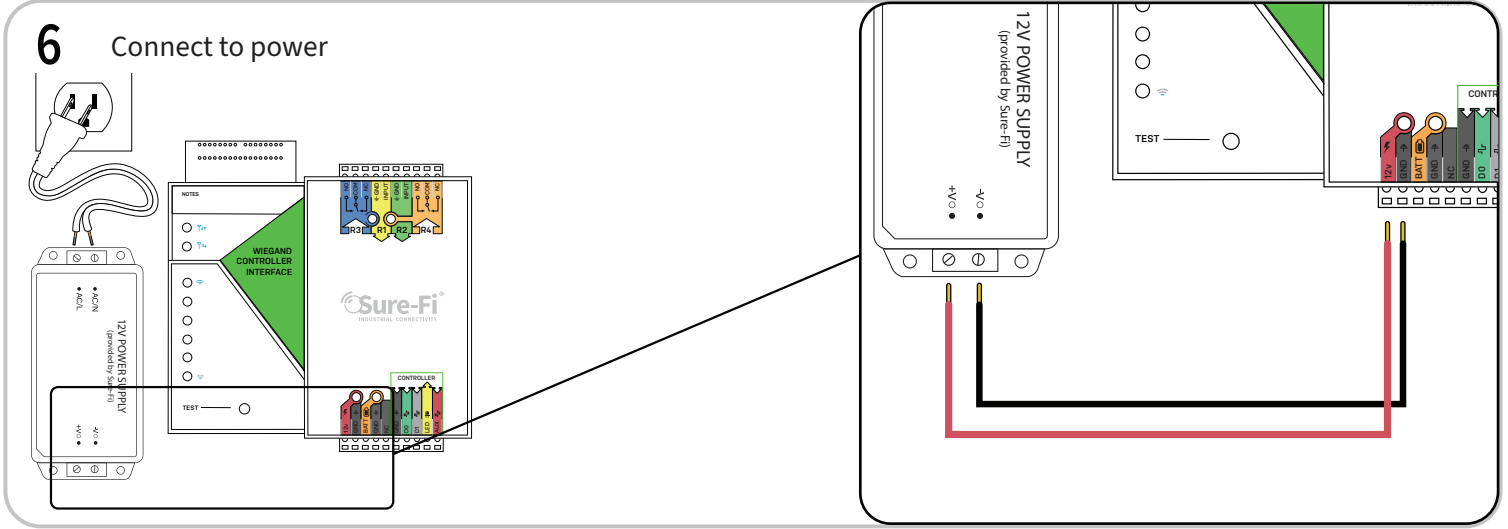

BEST PRACTICES

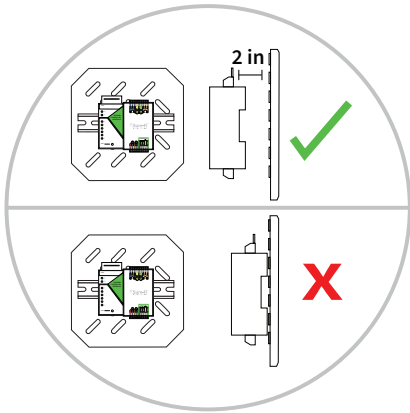

Mount spacing should be at least 2 inches away from any metal surface.

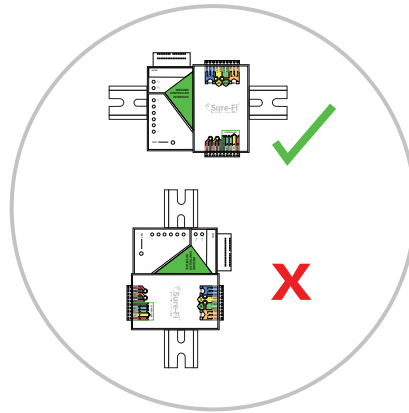

Mount in the vertical upright position

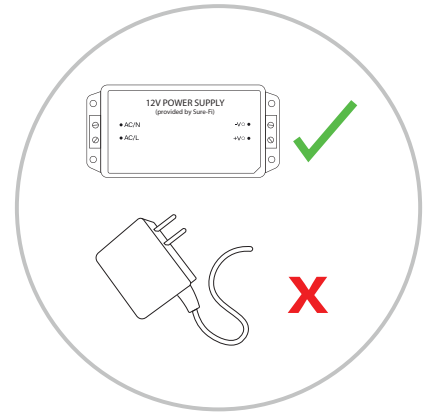

Use only specified/included power supplies

ADDITIONAL RESOURCES

While this quick start guide only goes over our most common applications, more wiring diagrams can be found under the “documentation” tab on this products listing on our website.