

ACCESS PRO KIT QUICK START GUIDE

ITEMS INCLUDED:

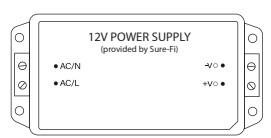

2x

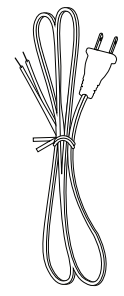

2x

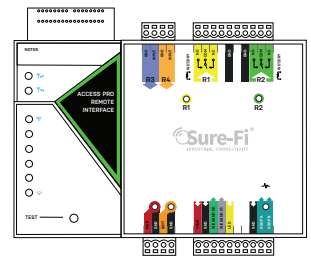

1x

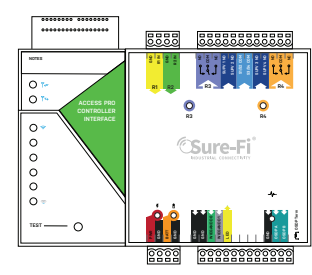

1x

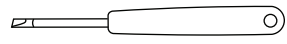

1x

SIDE 1 - REMOTE INTERFACE

1A Connect to Wiegand device

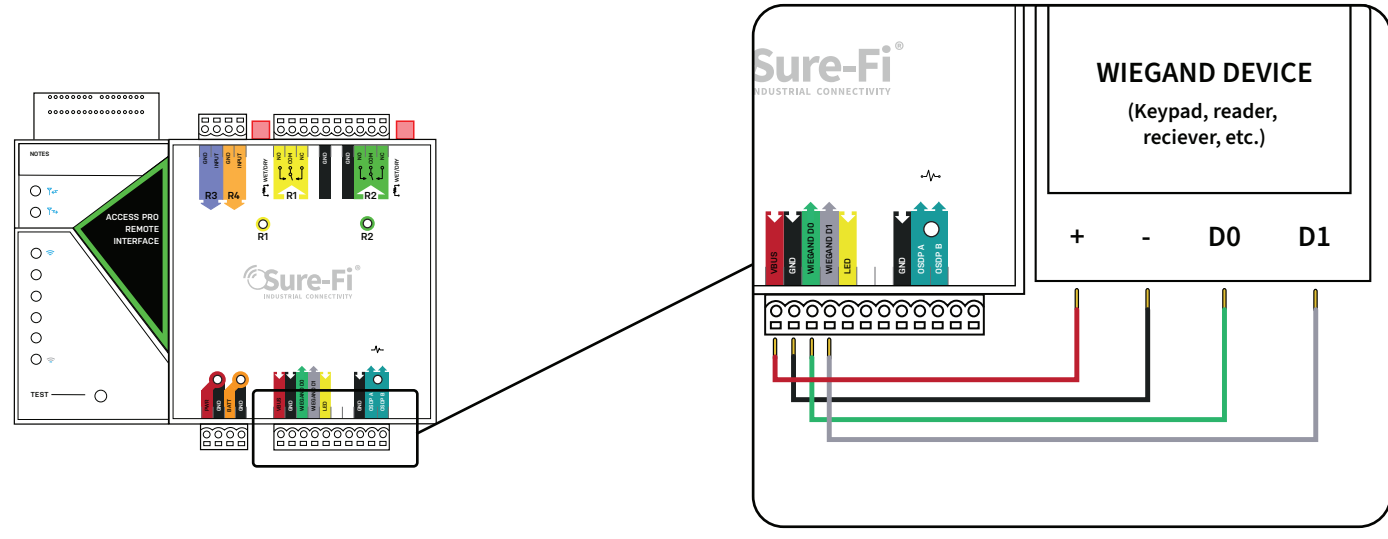

AND/OR

1B Connect to OSDP device

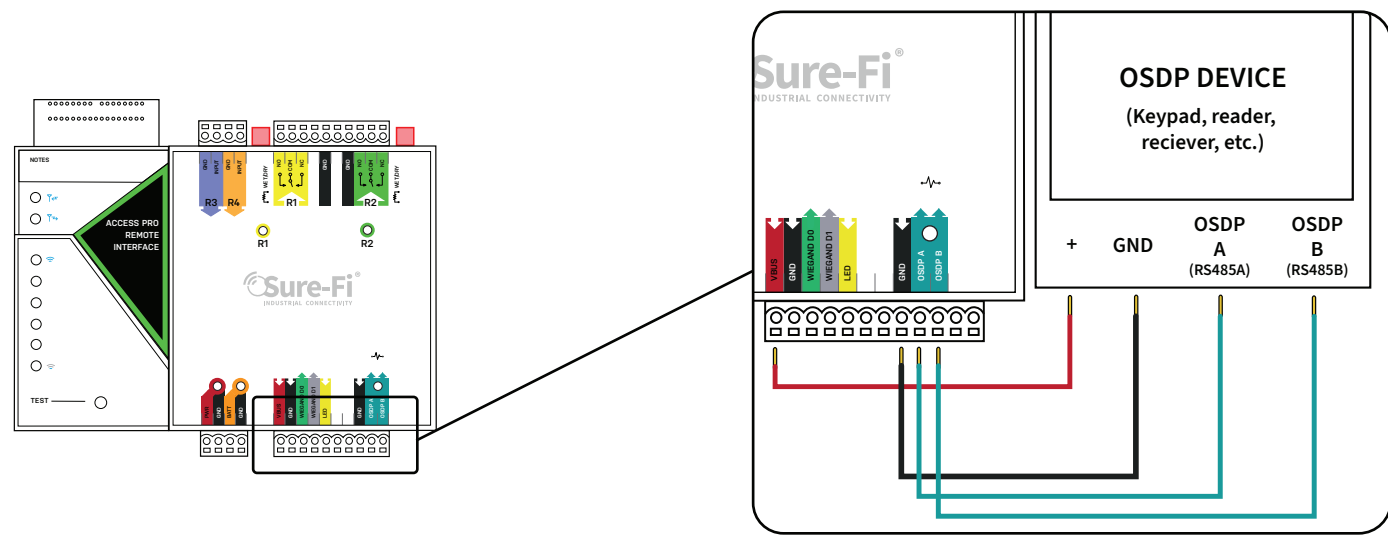

2A Connect relay outputs to the door or gate hardware

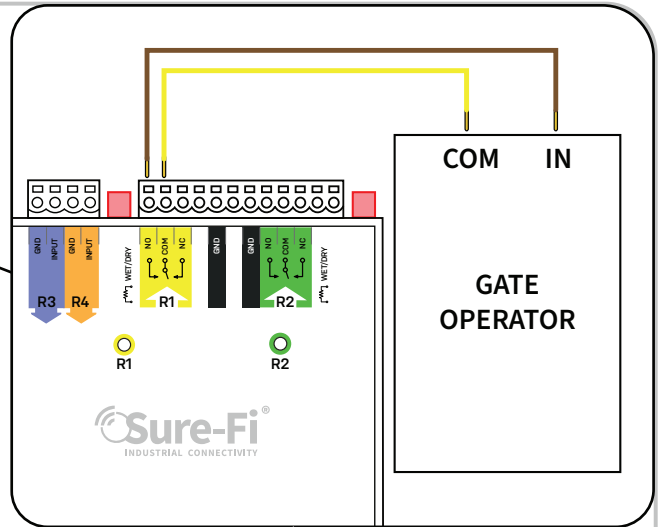
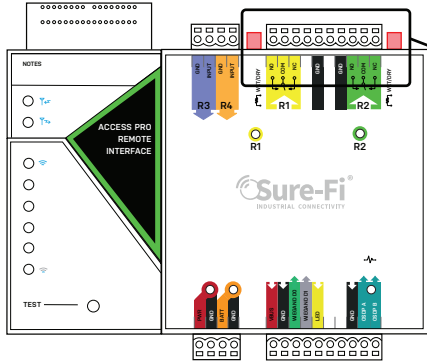

AND/OR

2B

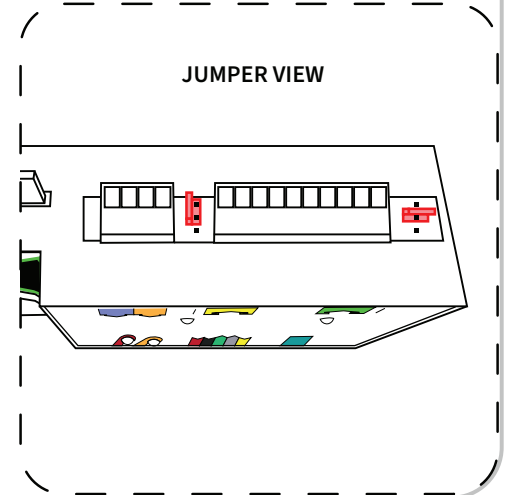
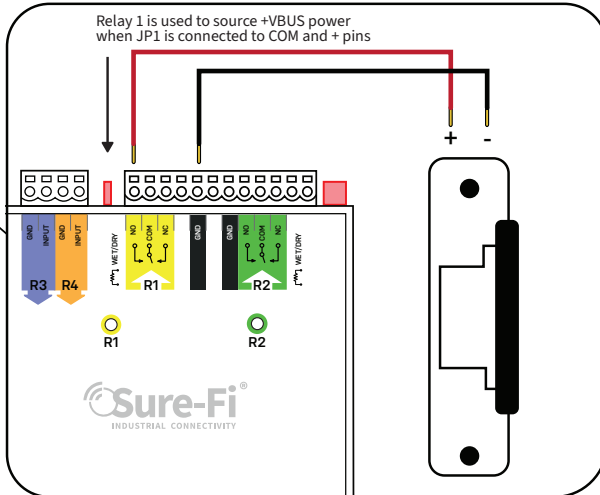
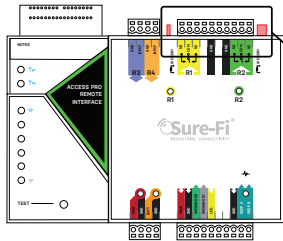

3 Connect to power

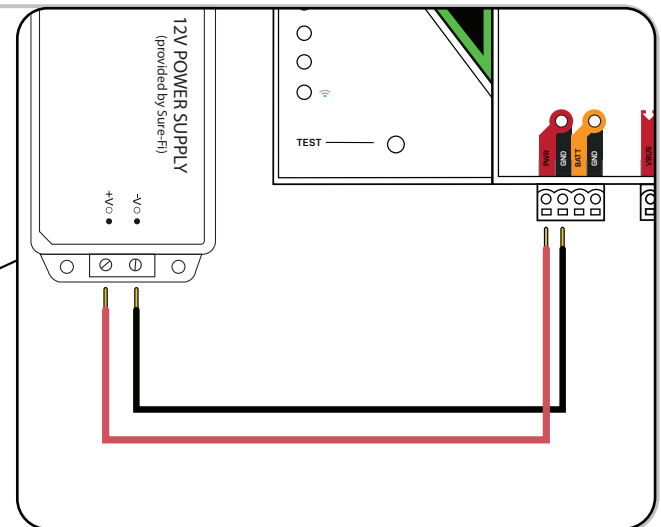
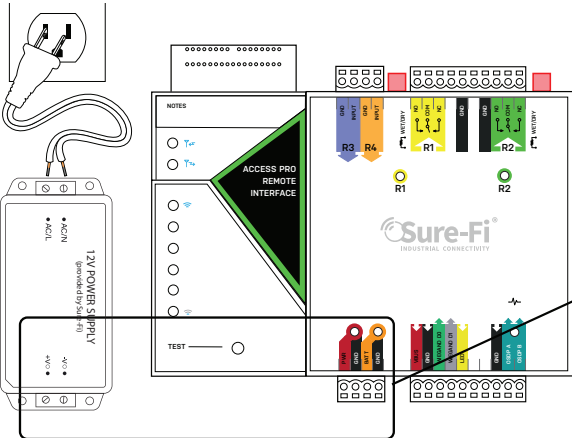

SIDE 2 - CONTROL PANEL

4 Connect controller interface OSDP and or wiegand data to control panel

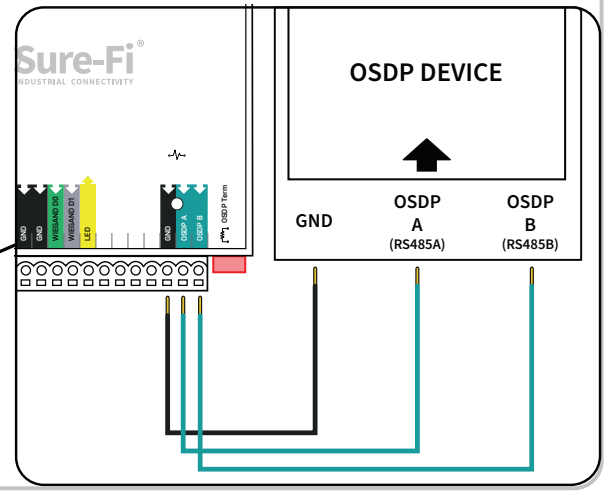
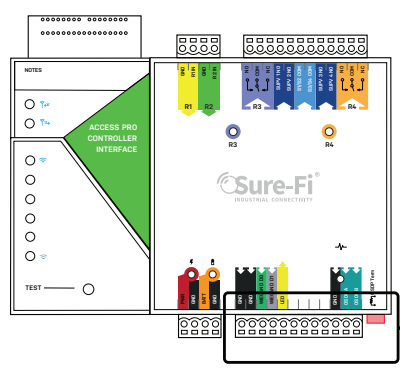
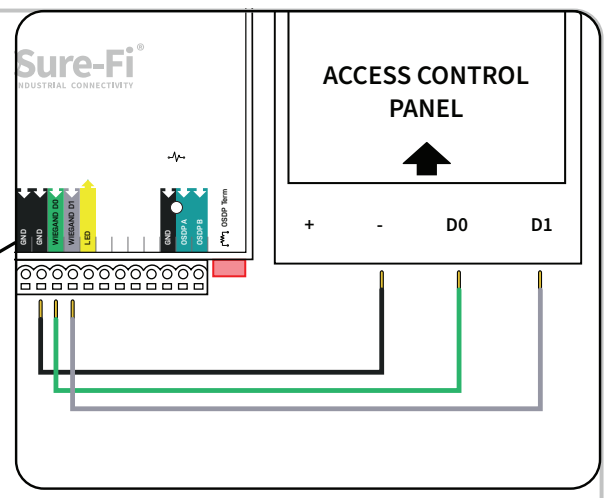
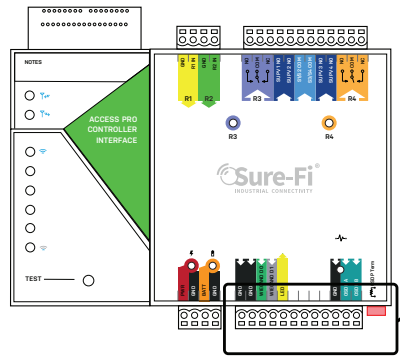

5 Connect relay input wires from control panel

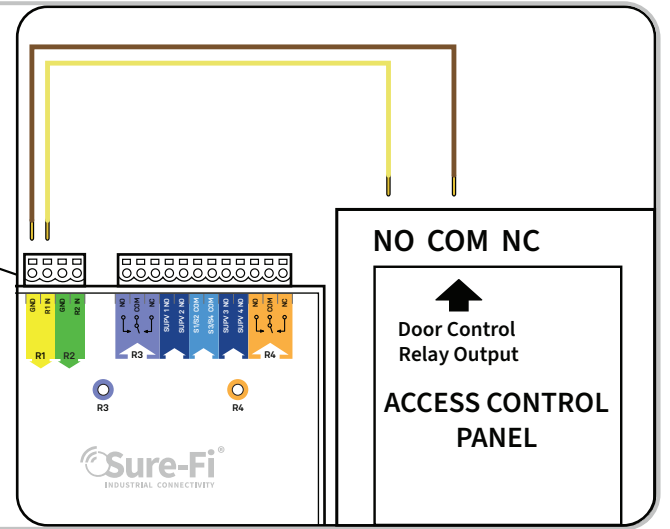
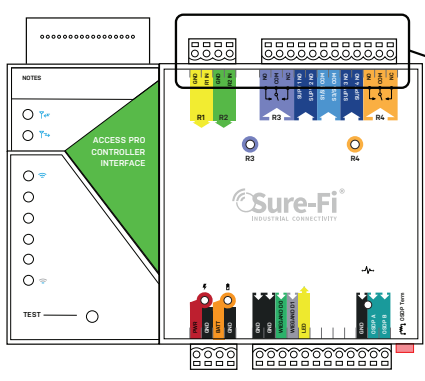

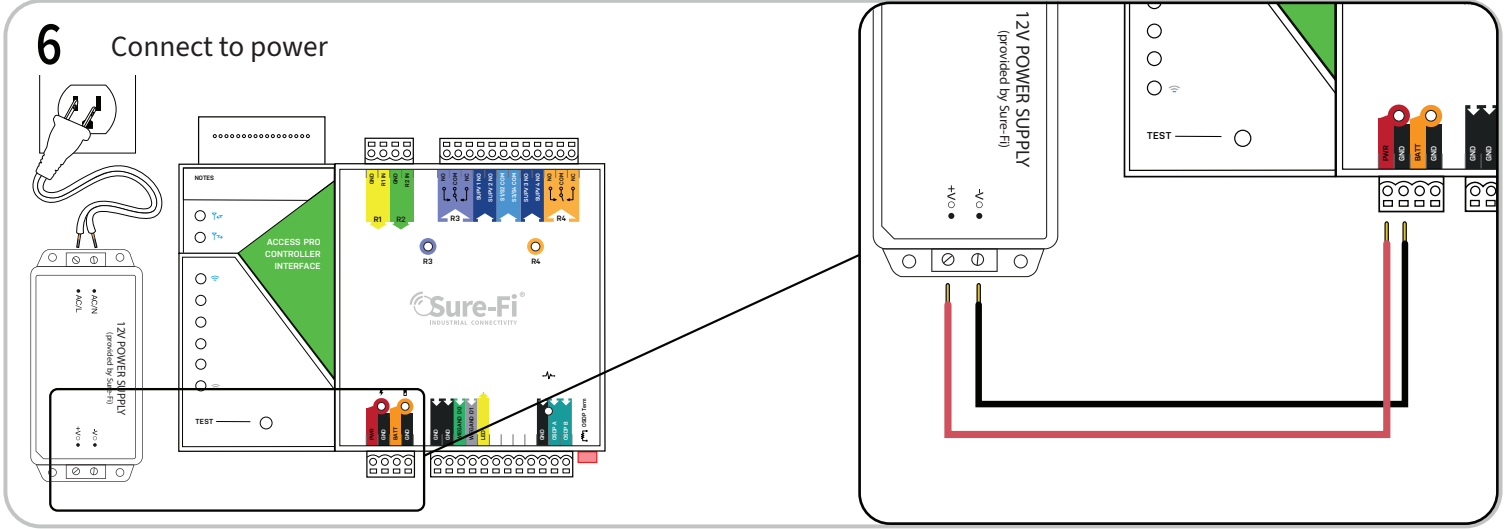

BEST PRACTICES

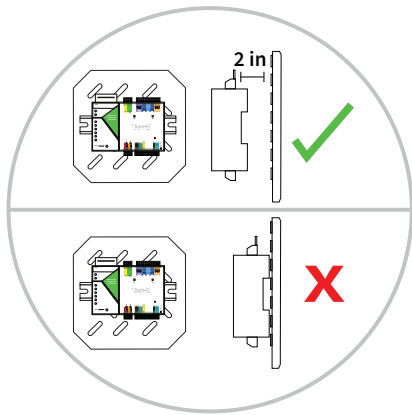

Mount spacing should be at least 2 inches away from any metal surface.

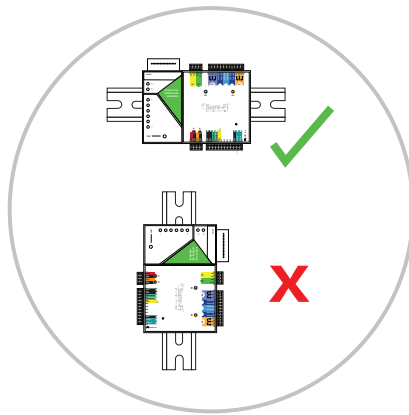

Mount in the vertical upright position

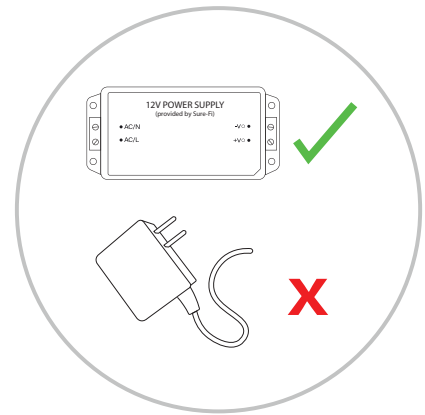

Use only specified/included power supplies

ADDITIONAL RESOURCES

While this quick start guide only goes over our most common applications, more wiring diagrams can be found under the “documentation” tab on this products listing on our website.